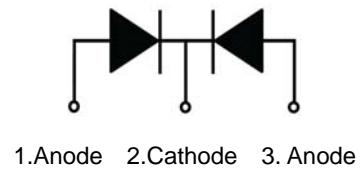
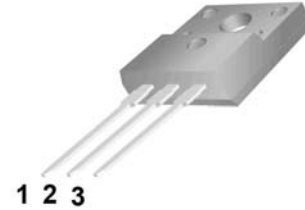

TO-220F

**MBRF3040CT-MBRF30200CT**
**Features:**

- Low power loss, high efficiency.  
High surge capacity
- For use in low voltage, high frequency inverters, free wheeling, and polarity protection applications.
- Metal silicon junction, majority carrier conduction.
- High current Capability, low forward voltage drop.
- Guard ring for over voltage protection.

**Absolute Maximum Ratings** (Ta=25°C unless otherwise noted)

Parameter	Symbol	MBRF 3040 CT	MBRF 3045 CT	MBRF 3050 CT	MBRF 3060 CT	MBRF 3080 CT	MBRF 3090 CT	MBRF 30100 CT	MBRF 30150 CT	MBRF 30200 CT	Unit
Maximum Recurrent Peak Reverse Voltage	$V_{RRM}$	40	45	50	60	80	90	100	150	200	V
Maximum RMS Voltage	$V_{RMS}$	28	31.5	35	42	56	63	70	105	140	
Maximum DC Blocking Voltage	$V_{R(DC)}$	40	45	50	60	80	90	100	150	200	
Maximum Average Forward Current	$I_{F(AV)}$	30									A
Peak Forward Surge Current:8.3ms single half sine-wave superimposed on rated load (JEDEC method)	$I_{FSM}$	275									
Maximum Forward Voltage at 15A per leg	$V_F$	0.7	0.75		0.85			0.95		V	
Maximum DC Reverse Current at Rated DC Blocking Voltage	$T_j=25^\circ\text{C}$	$I_R$	0.1								mA
	$T_j=125^\circ\text{C}$		20								
Maximum Operating Junction Temperature	$T_j$	150				175					°C
Storage Temperature	$T_{stg}$	-55~+150				-65~+175					
Typical Thermal Resistance	$R_{\theta JC}$	1.4									°C/W

Typical Characteristics

RATING AND CHARACTERISTIC CURVES

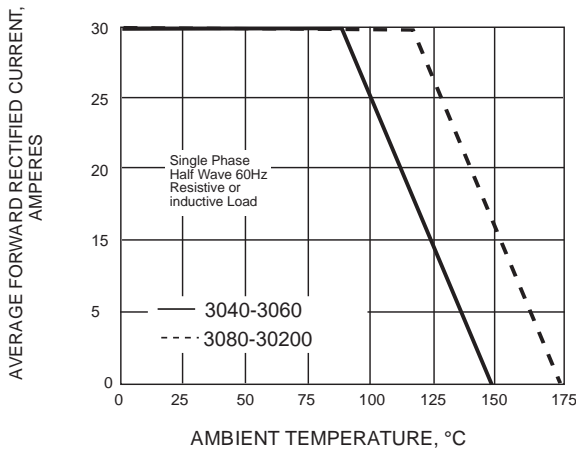

Fig.1 FORWARD CURRENT ERATING CURVE

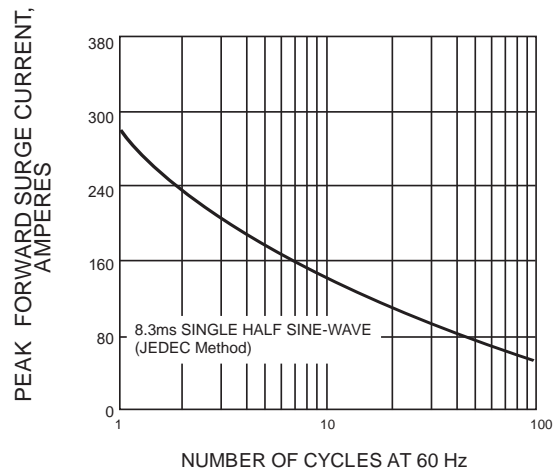

Fig.2 MAXIMUM NON-REPETITIVE SURGE CURRENT

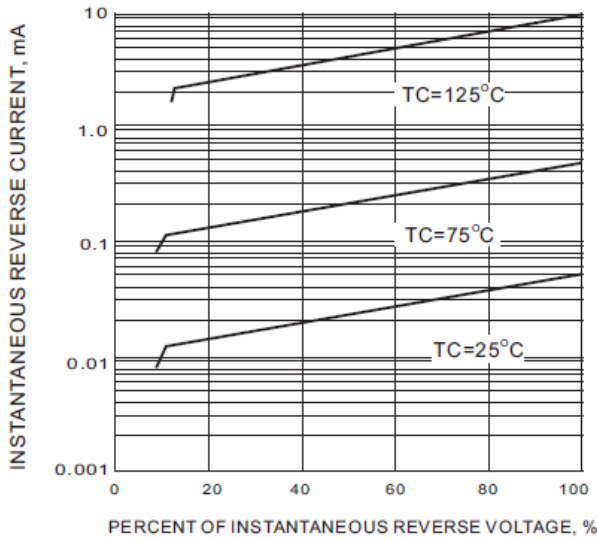

Fig.3 TYPICAL REVERSE CHARACTERISTIC

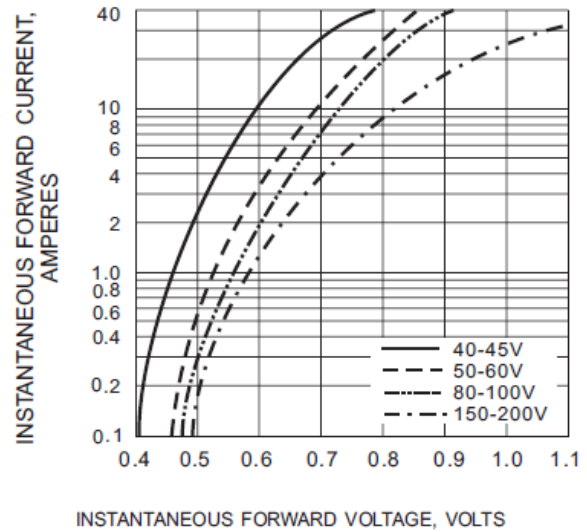
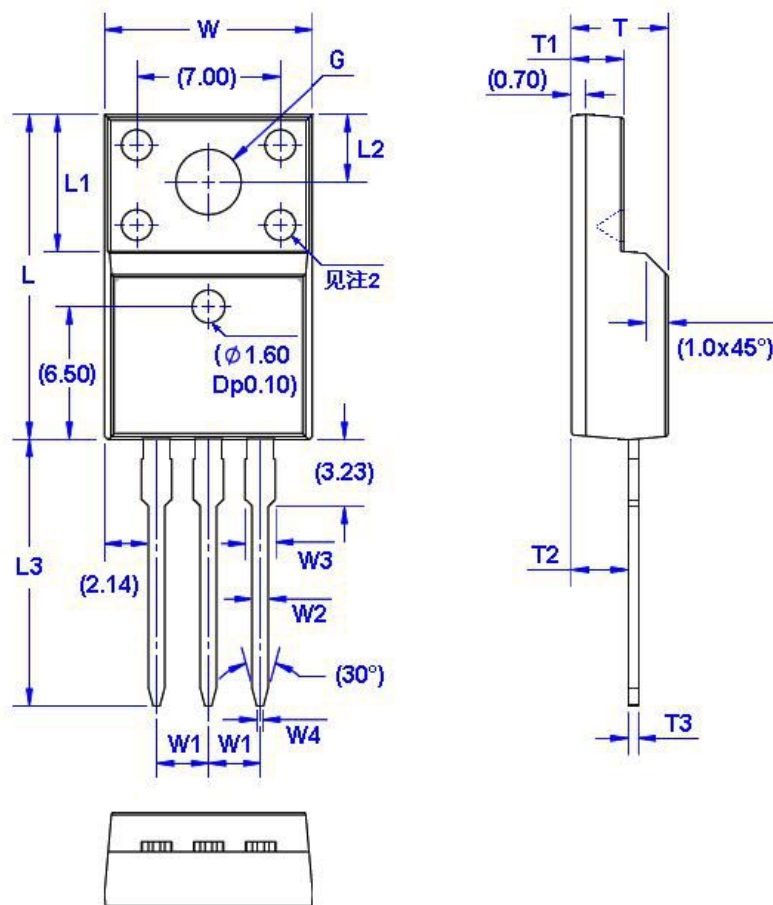

Fig.4 TYPICAL INSTANTANEOUS FORWARD CHARACTERISTIC

## Package Dimension

TO-220F

Unit: mm



Symbol	Size		Symbol	Size		Symbol	Size		Symbol	Size	
	Min	Max		Min	Max		Min	Max		Min	Max
W	9.96	10.36	W4	0.25	0.45	L3	12.78	13.18	T3	0.45	0.60
W1	2.54	(TYP)	L	15.67	16.07	T	4.50	4.90	G( $\Phi$ )	3.08	3.28
W2	0.70	0.90	L1	6.48	6.88	T1	2.34	2.74			
W3	1.24	1.47	L2	3.20	3.40	T2	2.56	2.96			