

107V N-Channel Enhancement Mode MOSFET

Description

The 80N10 T uses advanced technology to provide excellent $R_{DS(ON)}$, low gate charge and operation with gate voltages as low as 4.5V. This device is suitable for use as a Battery protection or in other Switching application.

General Features

$V_{DS} = 107V$ $I_D = 80A$

$R_{DS(ON)} < 9.0m\Omega$ @ $V_{GS}=10V$ (Type: 7.2m Ω)

Application

Isolated DC

Motor control

Synchronous-rectification

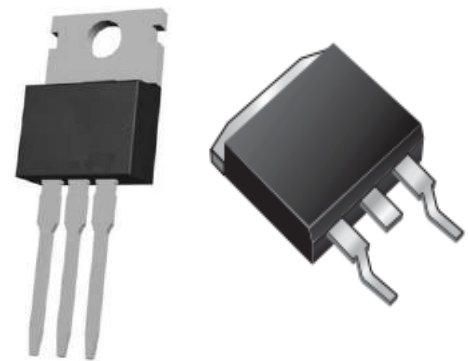
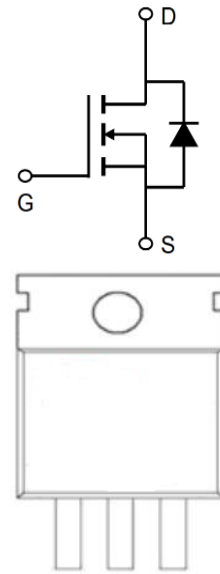

Absolute Maximum Ratings ($T_c=25^\circ C$ unless otherwise noted)

Symbol	Parameter	Rating	Units
V_{DS}	Drain-Source Voltage	107	V
V_{GS}	Gate-Source Voltage	± 20	V
$I_D@T_A=25^\circ C$	Continuous Drain Current ¹	80	A
$I_D@T_A=70^\circ C$	Continuous Drain Current ¹	62	A
IDM	Pulsed Drain Current ²	210	A
EAS	Single Pulse Avalanche Energy ³	100	mJ
IAS	Avalanche Current	15	A
$P_D@T_A=25^\circ C$	Total Power Dissipation ⁴	100	W
TSTG	Storage Temperature Range	-55 to 150	$^\circ C$
T_J	Operating Junction Temperature Range	-55 to 150	$^\circ C$
$R_{\theta JA}$	Thermal Resistance Junction-Ambient ¹	62	$^\circ C/W$
$R_{\theta JC}$	Thermal Resistance Junction-Case ¹	1.25	$^\circ C/W$

107V N-Channel Enhancement Mode MOSFET
Electrical Characteristics (T_c=25°C unless otherwise noted)

Symbol	Parameter	Conditions	Min.	Typ.	Max.	Unit
BVDSS	Drain-Source Breakdown Voltage	V _{GS} =0V, I _D =250uA	107	111	---	V
RDS(ON)	Static Drain-Source On-Resistance ²	V _{GS} =10V, I _D =30A	---	7.2	9.0	mΩ
	Static Drain-Source On-Resistance ²	V _{GS} =4.5V, I _D =12A	---	9.0	11	
VGS(th)	Gate Threshold Voltage	V _{GS} =V _{DS} , I _D =250uA	1.2	1.8	2.5	V
IDSS	Drain-Source Leakage Current	V _{DS} =100V, V _{GS} =0V, T _J =25°C	---	---	1	uA
		V _{DS} =100V, V _{GS} =0V, T _J =55°C	---	---	5	
IGSS	Gate-Source Leakage Current	V _{GS} =±20V, V _{DS} =0V	---	---	±100	nA
Qg	Total Gate Charge (10V)	V _{DS} =50V, V _{GS} =10V, I _D =25A	---	49.9	---	nC
Qg	Total Gate Charge (4.5V)		---	6.5	---	
Qgs	Gate-Source Charge		---	12.4	---	
Qgd	Gate-Drain Charge		---	3.4	---	
Td(on)	Turn-On Delay Time	V _{DD} =50V, V _{GS} =10V, R _G =2.2Ω, I _D =25A	---	20.6	---	ns
Tr	Rise Time		---	5	---	
Td(off)	Turn-Off Delay Time		---	51.8	---	
Tf	Fall Time		---	9	---	
Ciss	Input Capacitance	V _{DS} =50V, V _{GS} =0V, f=1MHz	---	2640	---	pF
Coss	Output Capacitance		---	361	---	
Crss	Reverse Transfer Capacitance		---	6.5	---	
IS	Continuous Source Current ^{1,5}	V _G =V _D =0V, Force Current	---	---	5	A
VSD	Diode Forward Voltage ²	V _{GS} =0V, I _S =30A, T _J =25°C	---	---	1.3	V
trr	Reverse Recovery Time	V _r =50V I _S =12A, di/dt=100A/μs, T _J =25°C	---	60.4	---	nS
Q _{rr}	Reverse Recovery Charge		---	106	---	nC

Note :

- 1、 The data tested by surface mounted on a 1 inch 2 FR-4 board with 2OZ copper.
- 2、 The data tested by pulsed , pulse width ≅ 300us , duty cycle ≅ 2%
- 3、 The EAS data shows Max. rating . The test condition is V_{DD}=30V,V_{GS}=10V, L=0.3 mH, starting T_J=25 °C
- 4、 The power dissipation is limited by 150°C junction temperature
- 5、 The data is theoretically the same as I D and I DM , in real applications , should be limited by total power dissipation

Typical Characteristics

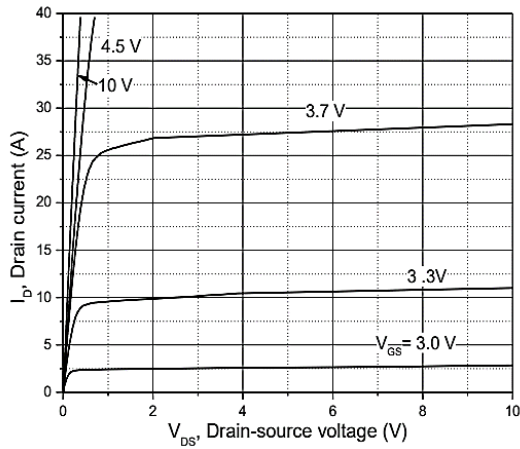

Figure 1. Typ. output characteristics

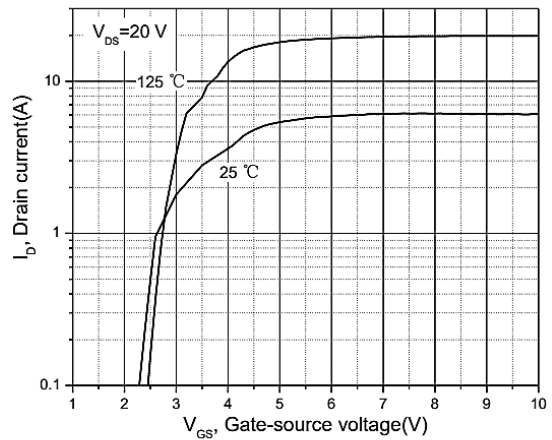

Figure 2. Typ. transfer characteristics

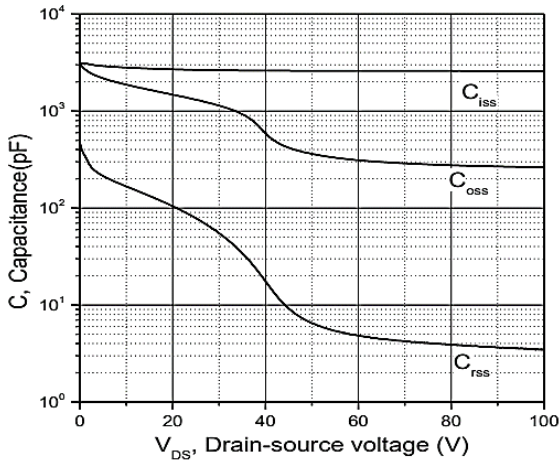

Figure 3. Typ. capacitances

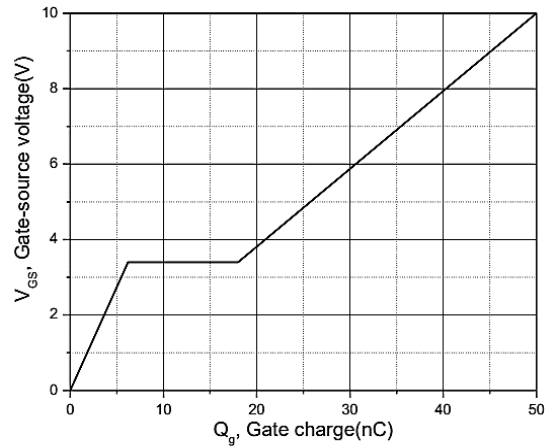

Figure 4. Typ. gate charge

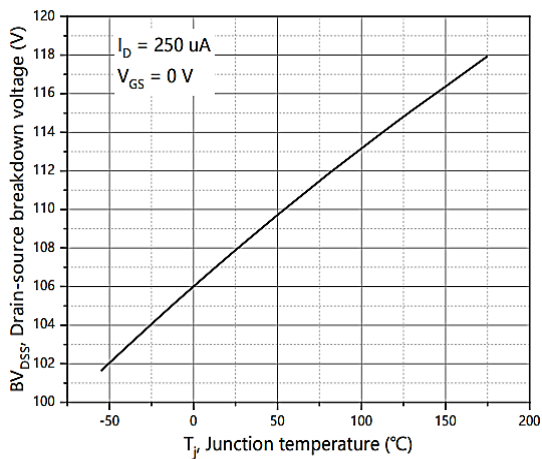

Figure 5. Drain-source breakdown voltage

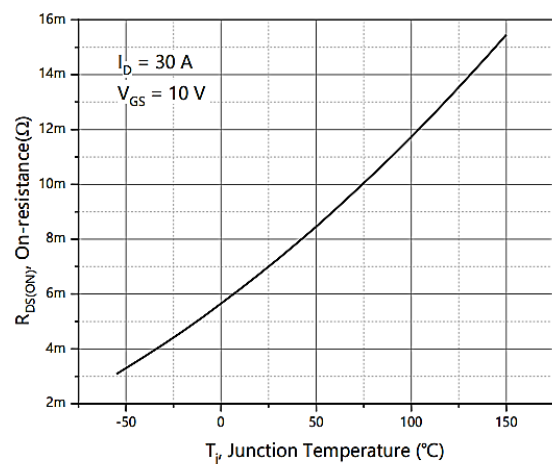
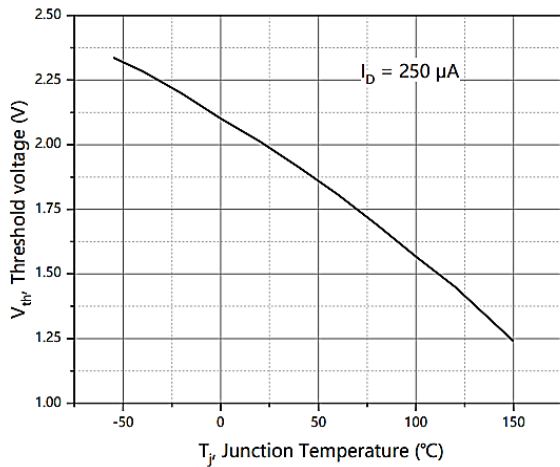
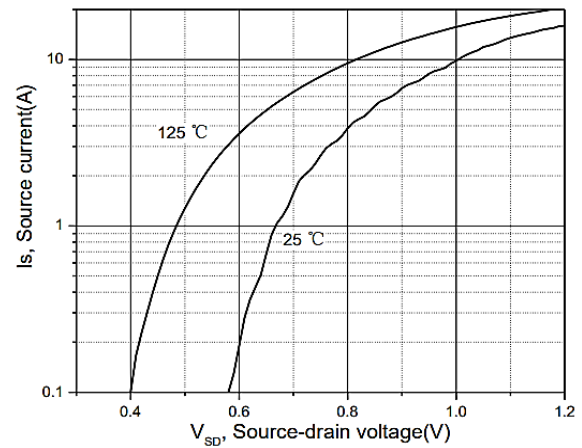
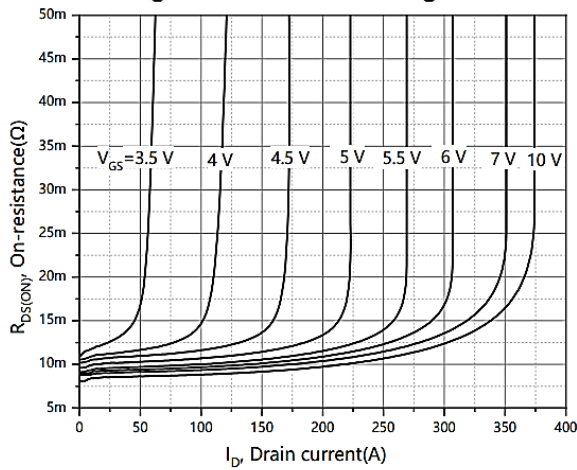
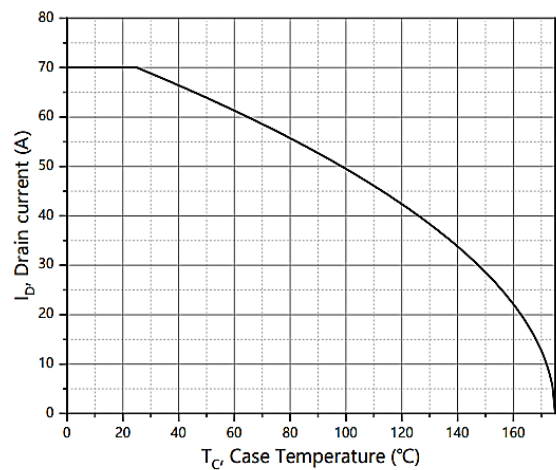
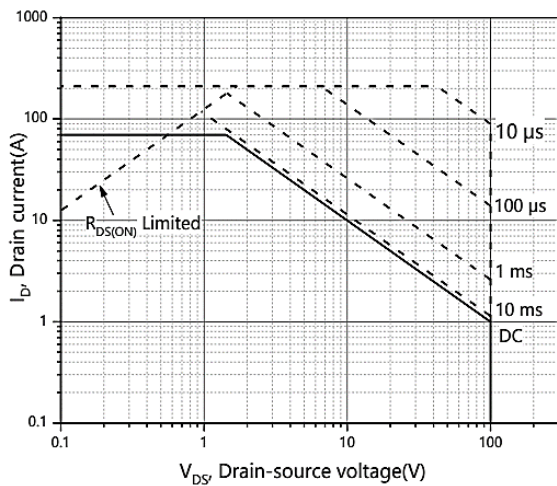
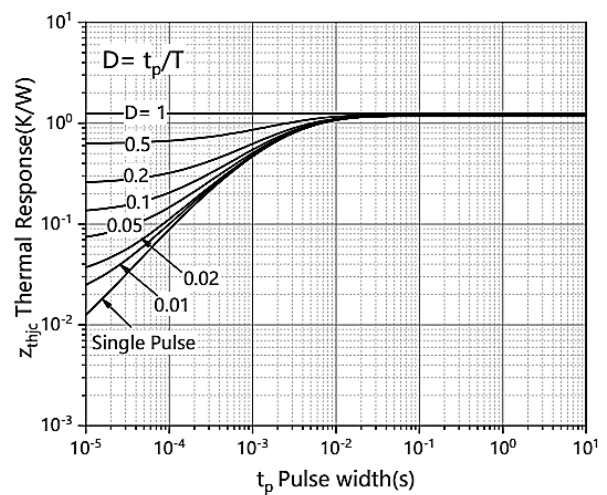
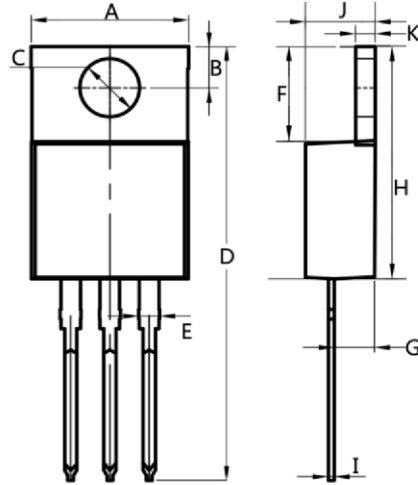

Figure 6. Drain-source on-state resistance

107V N-Channel Enhancement Mode MOSFET

Figure 7. Threshold voltage

Figure 8. Forward characteristic of body diode

Figure 9. Drain-source on-state resistance

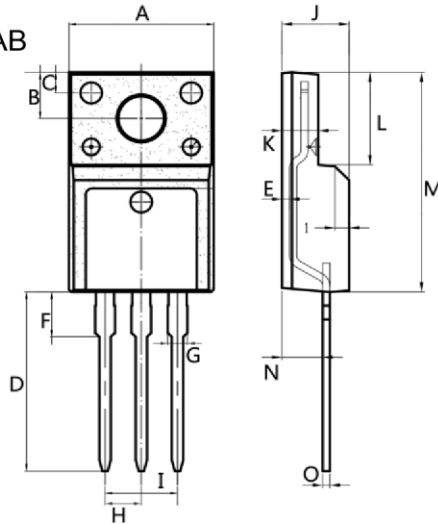
Figure 10. Drain current

Figure 11. Safe operation area $T_C=25\text{ }^\circ\text{C}$

Figure 12. Max. transient thermal impedance

107V N-Channel Enhancement Mode MOSFET
TO-220AB

Dim.	Min.	Max.
A	10.0	10.4
B	2.5	3.0
C	3.5	4.0
D	28.0	30.0
E	1.1	1.5
F	6.2	6.6
G	2.9	3.3
H	15.0	16.0
I	0.35	0.45
J	4.3	4.7
K	1.2	1.4

All Dimensions in millimeter

ITO-220AB

Dim.	Min.	Max.
A	9.9	10.3
B	2.9	3.5
C	1.15	1.45
D	12.75	13.25
E	0.55	0.75
F	3.1	3.5
G	1.25	1.45
H	Typ 2.54	
I	Typ 5.08	
J	4.55	4.75
K	2.4	2.7
L	6.35	6.75
M	15.0	16.0
N	2.75	3.15
O	0.45	0.60

All Dimensions in millimeter

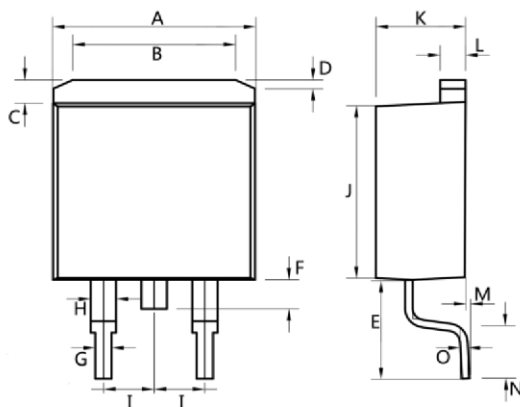
TO-263

Dim.	Min.	Max.
A	10.0	10.5
B	7.25	7.75
C	1.3	1.5
D	0.55	0.75
E	5.0	6.0
F	1.4	1.6
G	0.75	0.95
H	1.15	1.35
I	Typ 2.54	
J	8.4	8.6
K	4.4	4.6
L	1.25	1.45
M	0.02	0.1
N	2.4	2.8
O	0.35	0.45

All Dimensions in millimeter