

## 1. Description

This Power MOSFET is produced using XXW advanced planar stripe DMOS technology. This advanced technology has been especially tailored to minimize on-state resistance, provide superior switching performance, and withstand high energy pulse in the avalanche and commutation mode. These devices are well suited for high efficiency switched mode power supplies, active power factor correction based on half bridge topology.

## 2. Features

- n  $R_{DS(on)}=1.05\Omega @ V_{GS}=10\text{ V}$
- n Low gate charge ( typical 70 nC)
- n High ruggedness
- n Fast switching
- n 100% avalanche tested
- n Improved dv/dt capability
- n ESD Improved capability

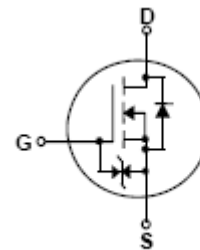
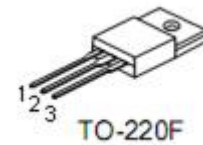

## 3. Pin configuration

Pin	Function
1	Gate
2	Drain
3	Source

## 4. Absolute maximum ratings

( $T_C = 25\text{ }^\circ\text{C}$ , unless otherwise specified)

Parameter	Symbol	Ratings	Units
Drain-source voltage	$V_{DSS}$	900	V
Drain current	$I_D$	$T_C=25\text{ }^\circ\text{C}$	9
		$T_C=100\text{ }^\circ\text{C}$	5.4
Drain current (note1)	$I_{DM}$	36	A
Gate-source Voltage	$V_{GSS}$	$\pm 30$	V
Single pulsed avalanche energy (note2)	$E_{AS}$	900	mJ
Avalanche current (note1)	$I_{AR}$	9	A
Repetitive avalanche energy (note1)	$E_{AR}$	28	mJ
Peak diode recovery dv/dt (note 3)	dv/dt	4.5	V/ns
Power dissipation	$P_D$	$T_C=25\text{ }^\circ\text{C}$	280
		Derate above $25\text{ }^\circ\text{C}$	2.22
Operating and storage temperature range	$T_J, T_{STG}$	-55 to +150	$^\circ\text{C}$
Maximum lead temperature for soldering purposes, 1/8" from case for 5 seconds	$T_L$	300	$^\circ\text{C}$

## 5. Thermal characteristics

Parameter	Symbol	Typ	Max	Units
Thermal resistance, junction-to-case	$R_{\theta JC}$	-	0.45	$^\circ\text{C/W}$
Thermal resistance, case-to-sink	$R_{\theta CS}$	0.24	-	$^\circ\text{C/W}$
Thermal resistance, junction-to-ambient	$R_{\theta JA}$	-	40	$^\circ\text{C/W}$

## 6. Electrical characteristics

 (T<sub>C</sub>=25°C, unless otherwise notes)

Parameter	Symbol	Test Conditions	Min	Typ	Max	Units
Off characteristics						
Drain-source breakdown voltage	BV <sub>DSS</sub>	V <sub>GS</sub> =0V, I <sub>D</sub> =250μA	900	-	-	V
Zero gate voltage drain current	I <sub>DSS</sub>	V <sub>DS</sub> =900V, V <sub>GS</sub> =0V	-	-	1	μA
		V <sub>DS</sub> =720V, T <sub>C</sub> =125°C	-	-	10	μA
Gate-body leakage current	Forward	I <sub>GSS</sub>	-	-	10	nA
	Reverse				-10	nA
Breakdown voltage temperature coefficient	ΔBV <sub>DSS</sub> /ΔT <sub>J</sub>	I <sub>D</sub> =250μA Referenced to 25°C	-	0.9	-	V/°C
On characteristics						
Gate threshold voltage	V <sub>GS(th)</sub>	V <sub>DS</sub> =V <sub>GS</sub> , I <sub>D</sub> =250μA	2.0	-	4.0	V
Static drain-source on-resistance	R <sub>DS(on)</sub>	V <sub>GS</sub> =10V, I <sub>D</sub> =4.5A	-	1.05	1.4	Ω
Forward transconductance	g <sub>FS</sub>	V <sub>DS</sub> =40V, I <sub>D</sub> =4.5A (note4)	-	9.0	-	S
Dynamic characteristics						
Input capacitance	C <sub>ISS</sub>	V <sub>DS</sub> =25V, V <sub>GS</sub> =0V, f=1.0MHz	-	2780	-	pF
Output capacitance	C <sub>OSS</sub>		-	228	-	pF
Reverse transfer capacitance	C <sub>RSS</sub>		-	28	-	pF
Switching characteristics						
Turn-on delay time	t <sub>D(ON)</sub>	V <sub>DD</sub> =450V, I <sub>D</sub> =9A, R <sub>G</sub> =25Ω (note4, 5)	-	55	-	ns
Rise time	t <sub>R</sub>		-	130	-	ns
Turn-off delay time	t <sub>D(OFF)</sub>		-	110	-	ns
Fall time	t <sub>F</sub>		-	80	-	ns
Total gate charge	Q <sub>G</sub>	V <sub>DS</sub> =720V, I <sub>D</sub> =9A, V <sub>GS</sub> =10V (note4, 5)	-	70	-	nC
Gate-source charge	Q <sub>GS</sub>		-	13.5	-	nC
Gate-drain charge	Q <sub>GD</sub>		-	27	-	nC
Drain-source diode characteristics and maximum ratings						
Maximum continuous drain-source diode forward current	I <sub>S</sub>		-	-	9	A
Maximum pulsed drain-source diode forward current	I <sub>SM</sub>		-	-	36	A
Drain-source diode forward voltage	V <sub>SD</sub>	V <sub>GS</sub> =0V, I <sub>S</sub> =9A	-	-	1.4	V
Reverse recovery time	t <sub>RR</sub>	V <sub>GS</sub> =0V, I <sub>S</sub> =9A, di <sub>F</sub> /dt=100A/μs (note 4)	-	850	-	ns
Reverse recovery charge	Q <sub>RR</sub>		-	10	-	μC

- Note: 1. Repetitive rating : pulse width limited by maximum junction temperature  
 2. L=21mH, I<sub>AS</sub>= 9A, V<sub>DD</sub>=50V, R<sub>G</sub>=25Ω, starting T<sub>J</sub>=25°C  
 3. I<sub>SD</sub>≤9A, di/dt≤200A/μs, V<sub>DD</sub>≤BV<sub>DSS</sub>, Starting T<sub>J</sub>=25°C  
 4. Pulse test : pulse width≤300μs, duty cycle≤2%  
 5. Essentially independent of operating temperature

## 7. Test circuits and waveforms

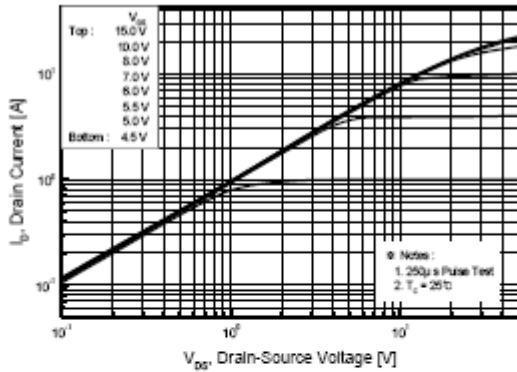

Figure 1. On-Region Characteristics

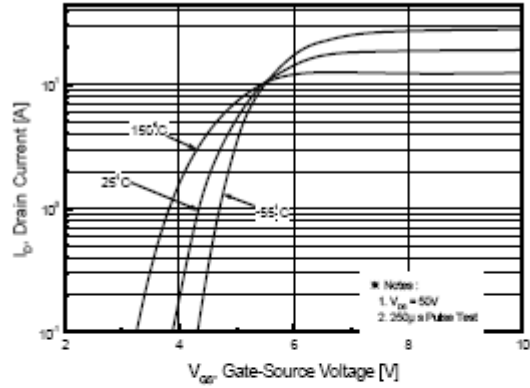

Figure 2. Transfer Characteristics

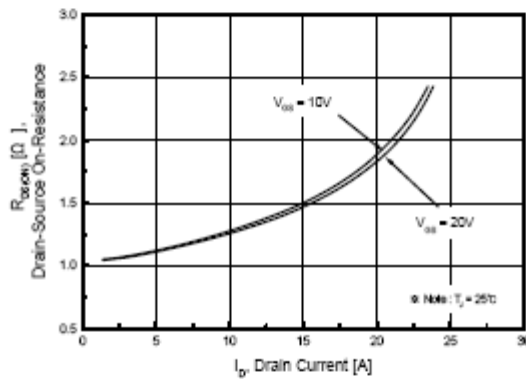

Figure 3. On-Resistance Variation vs Drain Current and Gate Voltage

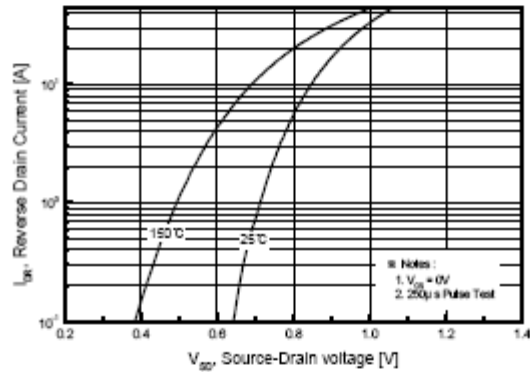

Figure 4. Body Diode Forward Voltage Variation with Source Current and Temperature

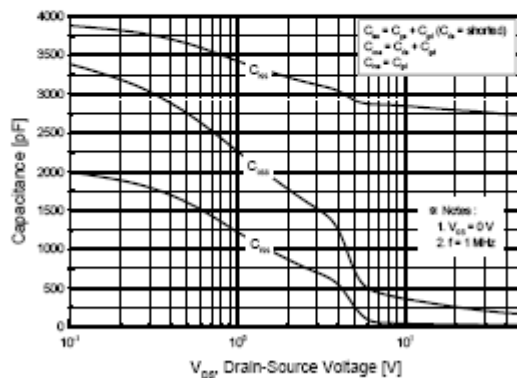

Figure 5. Capacitance Characteristics

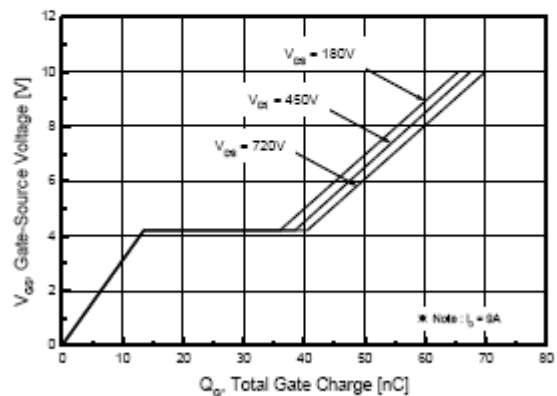
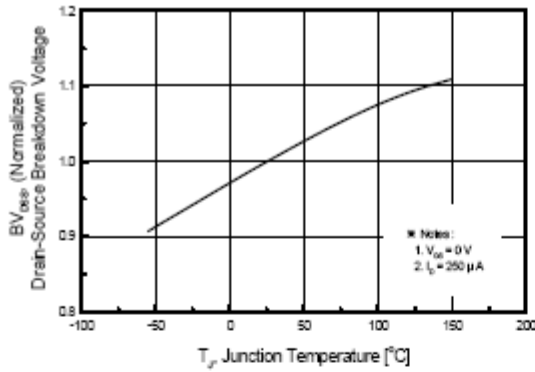
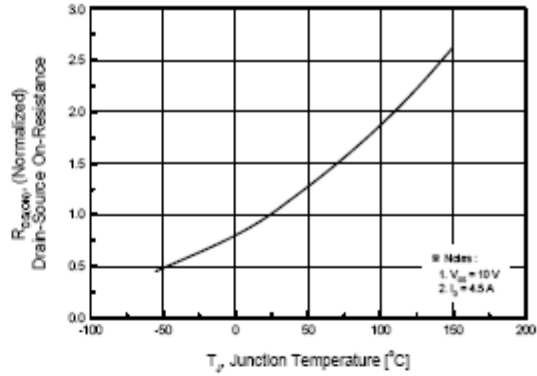

Figure 6. Gate Charge Characteristics



**Figure 7. Breakdown Voltage Variation vs Temperature**



**Figure 8. On-Resistance Variation vs Temperature**

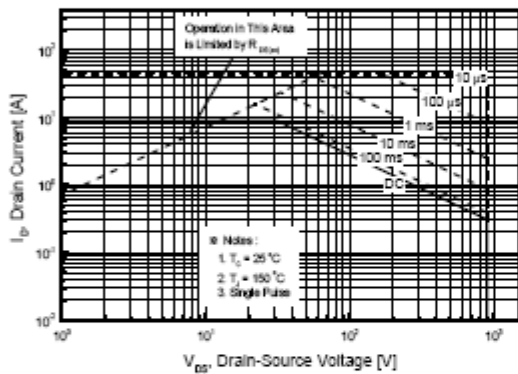

**Figure 9. Maximum Safe Operating Area**

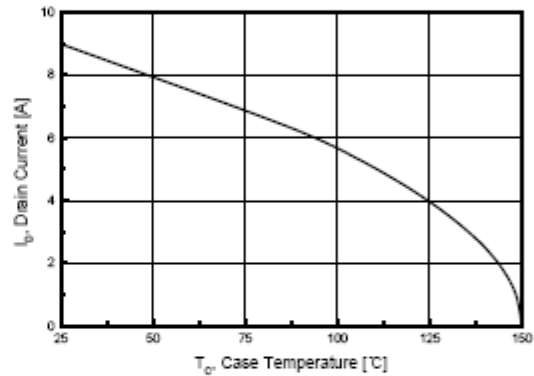

**Figure 10. Maximum Drain Current vs Case Temperature**

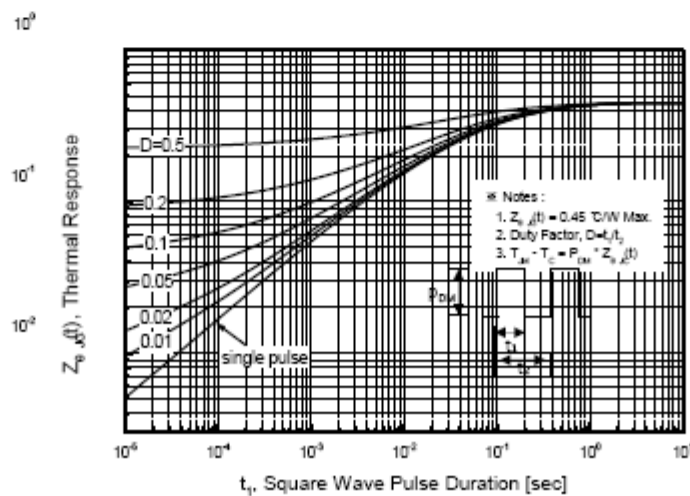

**Figure 11. Transient Thermal Response Curve**

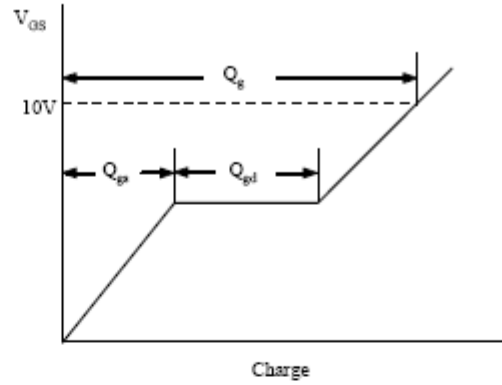
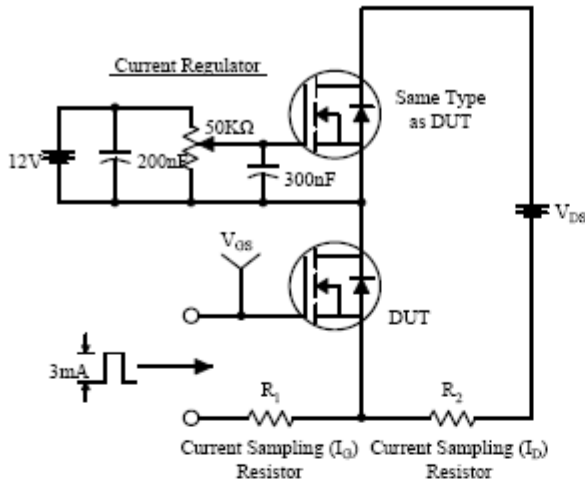

**Resistive Switching Test Circuit & Waveforms**

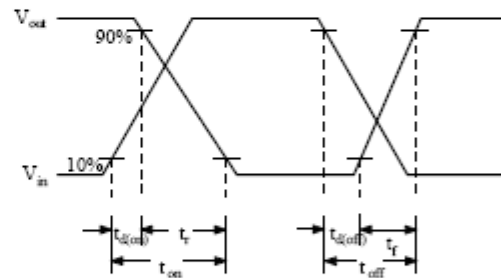
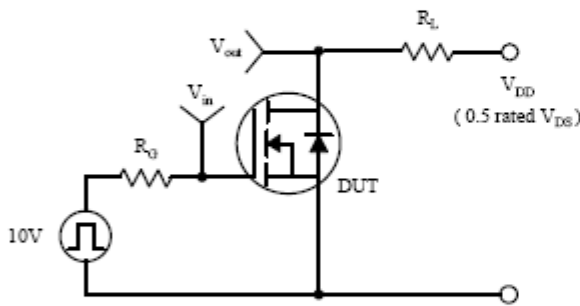

**Unclamped Inductive Switching Test Circuit & Waveforms**

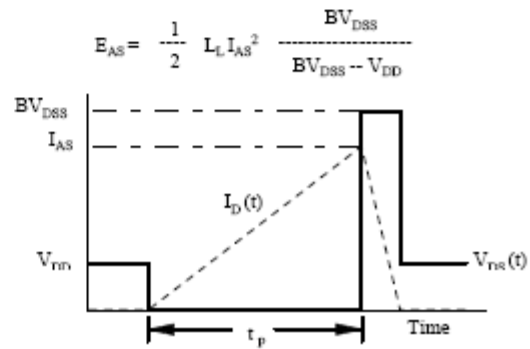
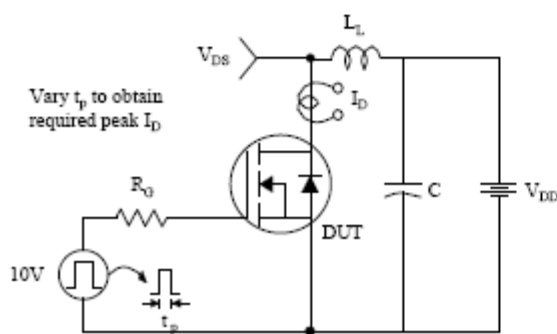

## Peak Diode Recovery dv/dt Test Circuit & Waveforms

